



PG907 ESERCIZIO BRACCIA

PG907 ARMS EXERCISES

VISTA TRIDIMENSIONALE

THREE-DIMENSIONAL VIEW

SCHEDA TECNICA (TECHNICAL DATA SHEET)		
ART. PG907	01-06-2017	SCALA (SCALE)
LE MISURE SONO ESPRESSE IN MM. (MEASUREMENTS ARE EXPRESSED IN MM.)		
	TOFFOLI GIOCHI SRL VIA BENEDETTO CROCE 7, Z.I. "CONDOTTI BARDINI", 31058 SUSEGANA (TV) 0438-460645	
	<small>Ci riserviamo a termini di Legge la proprietà di questo disegno con divieto di renderlo comunque noto a terzi senza la nostra approvazione. We reserve the right to read the ownership of this design with the prohibition of making it known to third parties without our approval.</small>	FOGLIO 1 DI 4

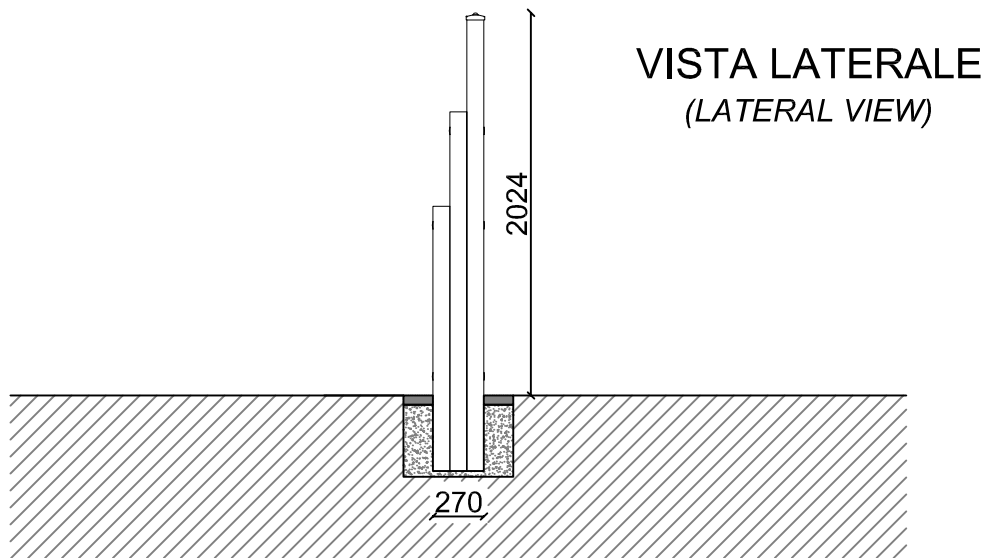
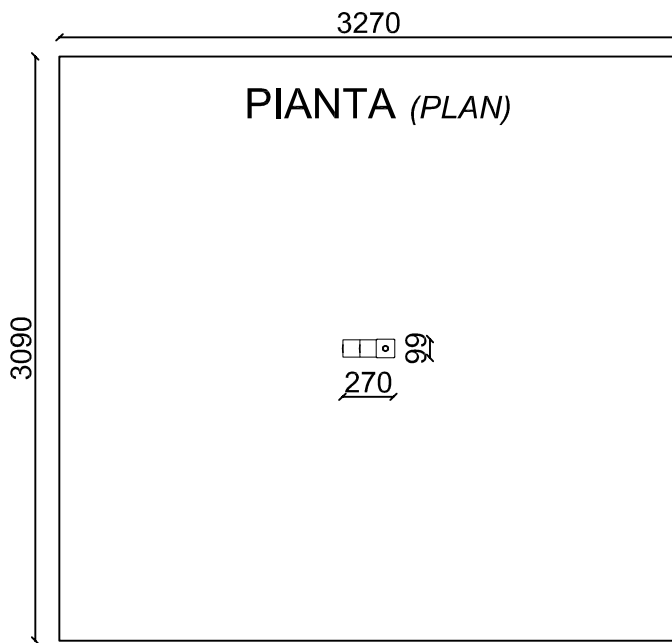

INGOMBRO MAX (OVERALL DIMENSIONS)



NUMERO UTILIZZATORI
(MAX N. OF SIMULTANEOUS USERS) 1



INGOMBRO (OVERALL DIMENSION)
27 cm x 10 cm x 202 cm H.



AREA DI SICUREZZA (SAFETY AREA)
327 cm x 310 cm

SCHEDA TECNICA (TECHNICAL DATA SHEET)		
ART. PG907	01-06-2017	SCALA (SCALE) 1:40
LE MISURE SONO ESPRESSE IN MM. (MEASUREMENTS ARE EXPRESSED IN MM.)		
	TOFFOLI GIOCHI SRL <small>VIA BENEDETTO CROCE 7, Z.I. "CONDOTTI BARDINI", 31058 SUSEGANA (TV) 0438-460645</small>	
	<small>Ci riserviamo a termini di Legge la proprietà di questo disegno con divieto di renderlo comunque noto a terzi senza la nostra approvazione. We reserve the right to read the ownership of this design with the prohibition of making it known to third parties without our approval.</small>	FOGLIO 2 DI 4

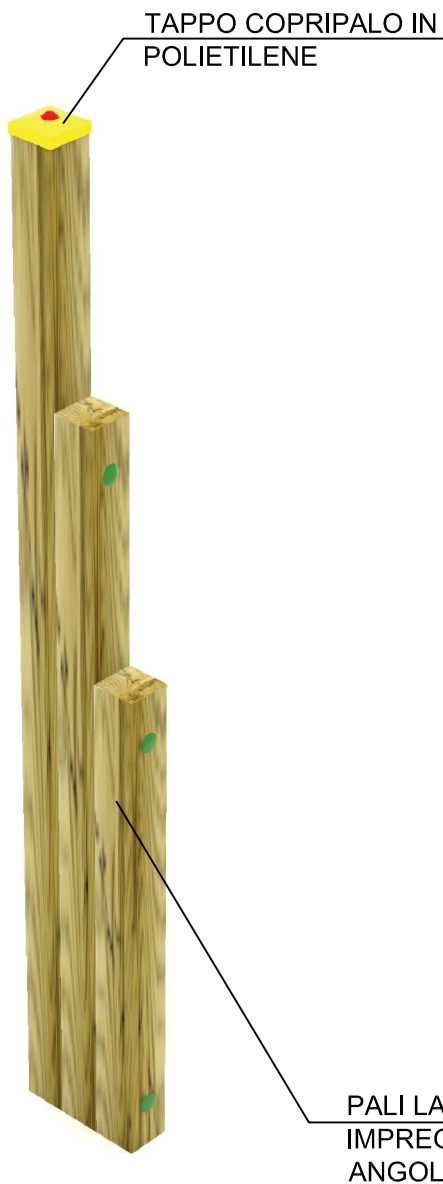

TAPPO COPRIPALO IN POLIETILENE

PALI LAMELLARI DI PINO NORDICO IMPREGNATO IN AUTOCLAVE CON ANGOLI ARROTONDATI DA 90X90MM.

TUTTI GLI ELEMENTI DI FISSAGGIO, VITI, DADI, RONDELLE ECC. SONO IN ACCIAIO INOSSIDABILE E PROTETTI DA GHIERE E TAPPI IN POLIETILENE

POSSIBILITA' DI ANCORAGGIO SU CLS MEDIANTE STAFFE IN ACCIAIO ZINCATO

SCHEDA TECNICA (TECHNICAL DATA SHEET)		
ART. PG907	01-06-2017	SCALA (SCALE)
LE MISURE SONO ESPRESSE IN MM. (MEASUREMENTS ARE EXPRESSED IN MM.)		
	TOFFOLI GIOCHI SRL VIA BENEDETTO CROCE 7, Z.I. "CONDOTTI BARDINI", 31058 SUSEGANA (TV) 0438-460645	
	<small>Ci riserviamo a termini di Legge la proprietà di questo disegno con divieto di renderlo comunque noto a terzi senza la nostra approvazione. We reserve the right to read the ownership of this design with the prohibition of making it known to third parties without our approval.</small>	FOGLIO 3 DI 4

TAPPO COPRI PALO IN POLIETILENE

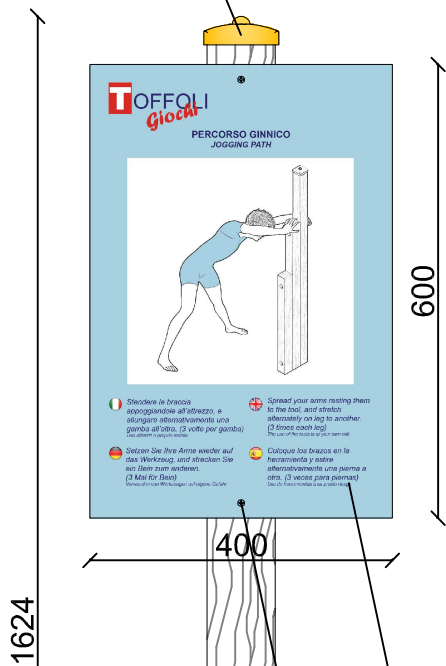

PIANTA (PLAN)

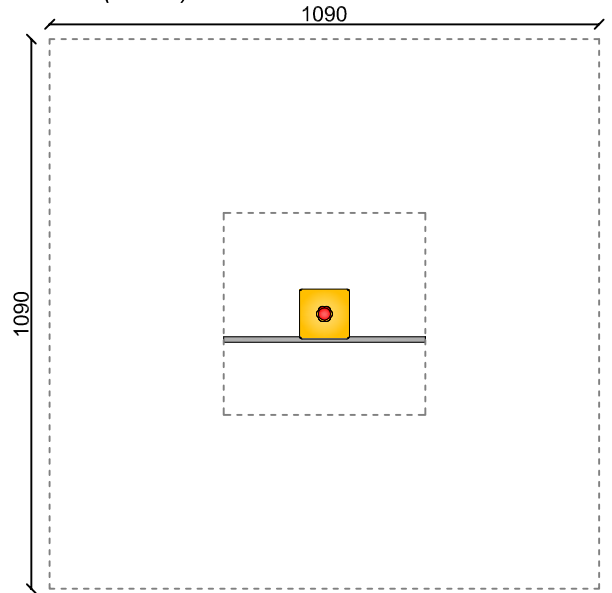

AREA DI SICUREZZA (SAFETY AREA) 1,09M X 1,09M

CARTELLLO CON STAMPA SU PVC 400X600XSP.10MM

TSP5X60 VITE TRUCIOLARE ZINCATA

PG913

PALO LAMELLARE DI PINO NORDICO IMPREGNATO IN AUTOCLAVE CON ANGOLI ARROTONDATI DA 90X90MM.

VISTA FRONTALE (FRONTAL VIEW)

POSSIBILITA' DI ANCORAGGIO SU CLS MEDIANTE STAFFE IN ACCIAIO ZINCATO

GETTO IN CLS 40CM X 40CM X H.40CM

SCHEDE TECNICA (TECHNICAL DATA SHEET)

ART. PG907

01-06-2017

SCALA (SCALE) 1:10 - 1:15

LE MISURE SONO ESPRESSE IN MM. (MEASUREMENTS ARE EXPRESSED IN MM.)



TOFFOLI GIOCHI SRL
 VIA BENEDETTO CROCE 7, Z.I. "CONDOTTI BARDINI", 31058 SUSEGANA (TV)
 0438-460645

Ci riserviamo a termini di Legge la proprietà di questo disegno con divieto di renderlo comunque noto a terzi senza la nostra approvazione.
 We reserve the right to read the ownership of this design with the prohibition of making it known to third parties without our approval.

FOGLIO 4 DI 4